



Getting started with
Logitech® Wireless Combo MK620



Contents

English

What's in the box, **3**
Setup, **4**

Features and troubleshooting, **10**

 www.logitech.com/support/mk620

 What's in the box

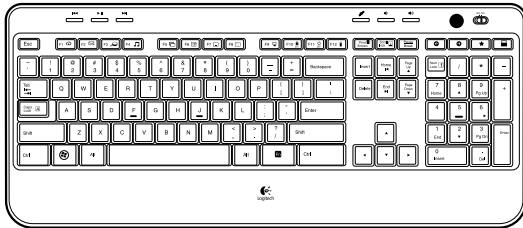

K520



M705

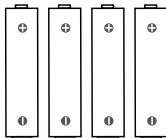

Set-up

1

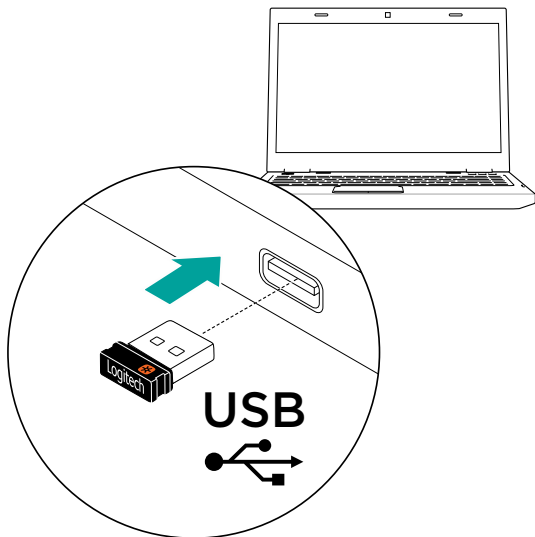

2

i

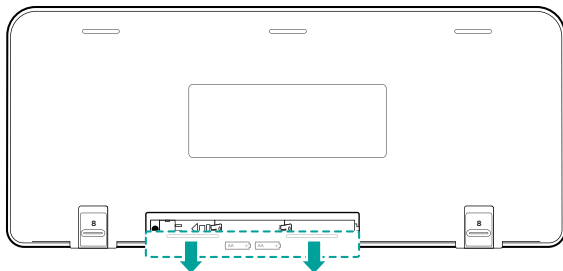

ii

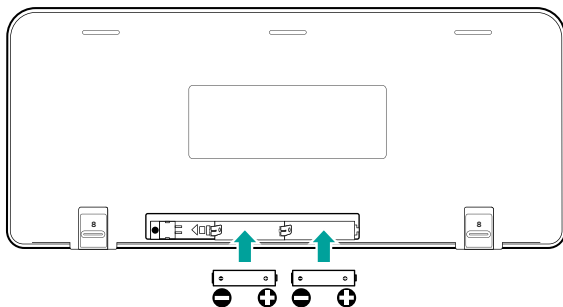

iii

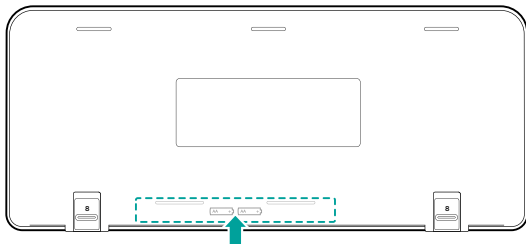

iv

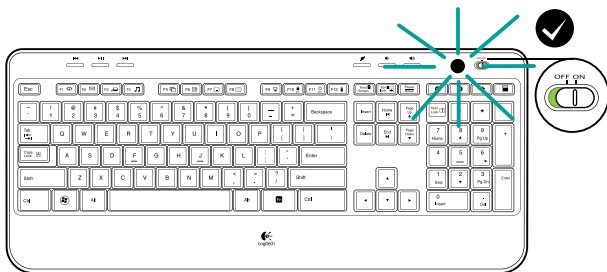

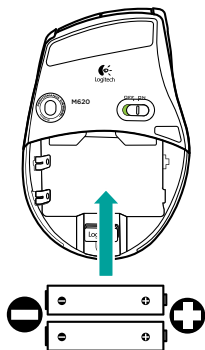
3**i****ii**

iii

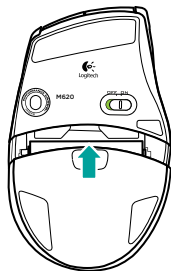

iv

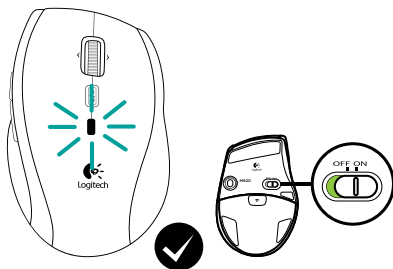



Your Keyboard and mouse are now ready for use. You can download the Logitech® SetPoint™ Software if you want to customize your keyboard keys and mouse buttons.

www.logitech.com/downloads

Keyboard features: F-key usage



User-friendly enhanced F-keys let you launch applications easily. To use the enhanced functions (yellow icons), first press and hold the **FN** key; second, press the F-key you want to use.

Tip In the software (SetPoint) settings, you can invert the FN mode if you prefer to access directly the enhanced functions without having to press the FN key.

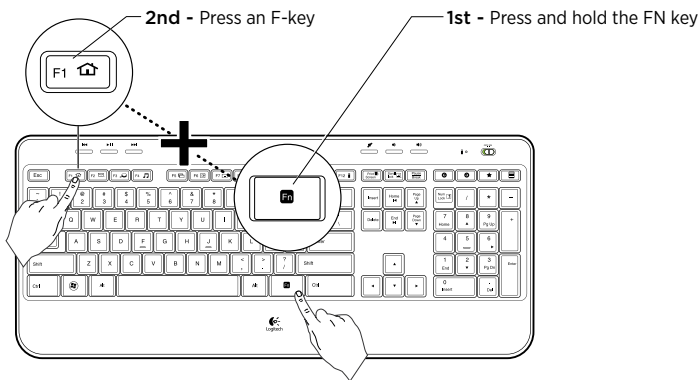

Keyboard features

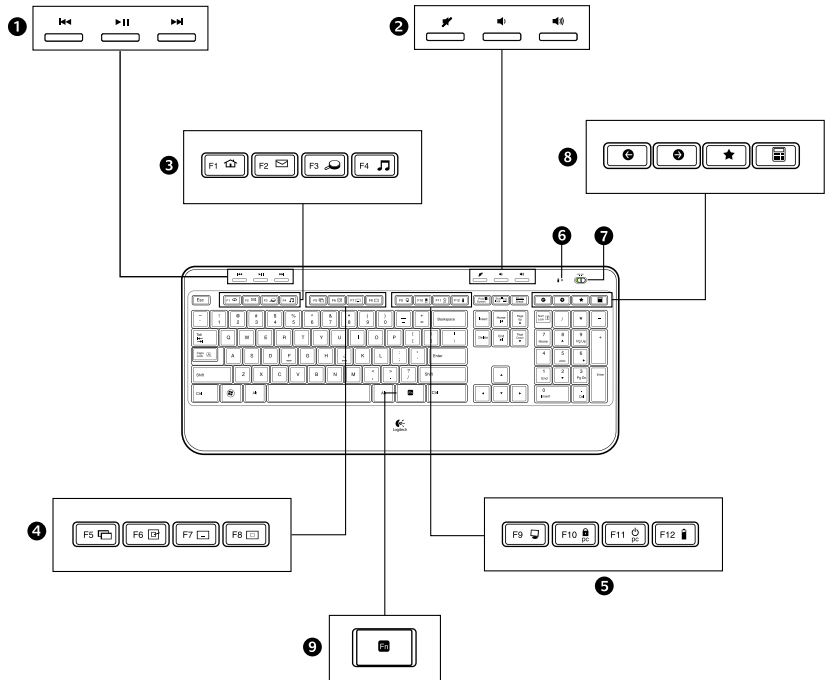

Keyboard features

1. Multimedia navigation
2. Volume adjustment
3. Application zone
 - FN** + F1 Launches Internet browser
 - FN** + F2 Launches e-mail application
 - FN** + F3 Launches Windows Search*
 - FN** + F4 Launches media player
4. Windows view controls
 - FN** + F5 Flip†
 - FN** + F6 Shows Desktop
 - FN** + F7 Minimizes window
 - FN** + F8 Restores minimized windows
5. Convenience zone
 - FN** + F9 My Computer
 - FN** + F10 Locks PC
 - FN** + F11 Puts PC in standby mode
 - FN** + F12 Keyboard battery status check
6. Battery status indicator
7. Keyboard power switch
8. Internet navigation
 - Internet back & forward navigation
 - Internet favorites
 - Launches calculator

* One Touch Search if the SetSpoint® software is installed.

† Application Switcher if the SetSpoint® software is installed.

Mouse features

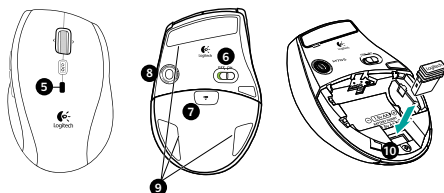
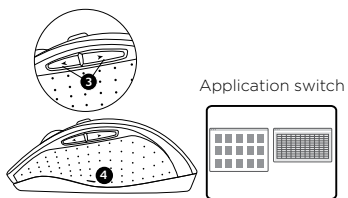
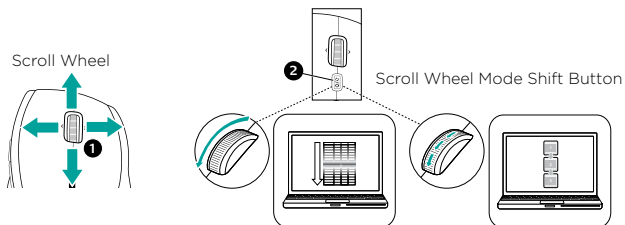

Mouse features

1. Scroll Wheel – Press for middle button; tilts for side-to-side scrolling.*
2. Scroll Wheel Mode Shift Button – Press to shift between hyper-fast (free-spinning) and precision (click-to-click) scrolling.
3. Back and Forward Buttons* – Press to flip between web pages.
4. Application Switch* – Press rubber grip to switch between applications.
5. Battery Indicator Light – Turns red when a couple weeks of battery life remain.
6. On/Off Button – Slide to turn mouse on and off.
7. Battery Door Release – Press where indicated and slide door off mouse. Reduce weight by installing a single battery.
8. Laser engine – Delivers smooth, responsive, and precise cursor control.
9. Slots – Use to remove worn mouse feet.
10. Receiver storage.

* Application Switcher and side-to-side scrolling require Logitech software (SetPoint). Depending on your operating system, the back, forward, and middle buttons may also require Logitech software.

Battery management

Your keyboard and mouse have up to three years of battery life.*

Battery sleep mode

Did you know that your keyboard and mouse go into sleep mode after you stop using them for a few minutes? This feature helps limit battery usage and eliminates the need to keep switching your devices on and off. Both your keyboard and mouse are up and running immediately once you begin using them again.

How to check the battery level for the keyboard

Press and hold the FN key, then press the F12 key: If the LED glows green, the batteries are good. If the LED blinks red, the battery level is low and you should consider changing batteries.

You can also turn the keyboard off then back on using the On/Off switch on top of the keyboard.

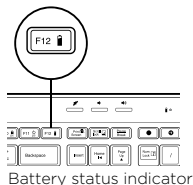

How to check the battery level for the mouse

Turn the mouse **off** then back **on** using the On/Off switch on the mouse bottom. If the LED on top of the mouse glows green for 10 seconds, the batteries are good. If the LED blinks red, the battery level is low and you should consider changing batteries.

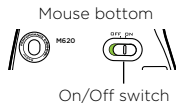

* Battery life varies with usage and computing conditions. Heavy usage usually results in shorter battery life.

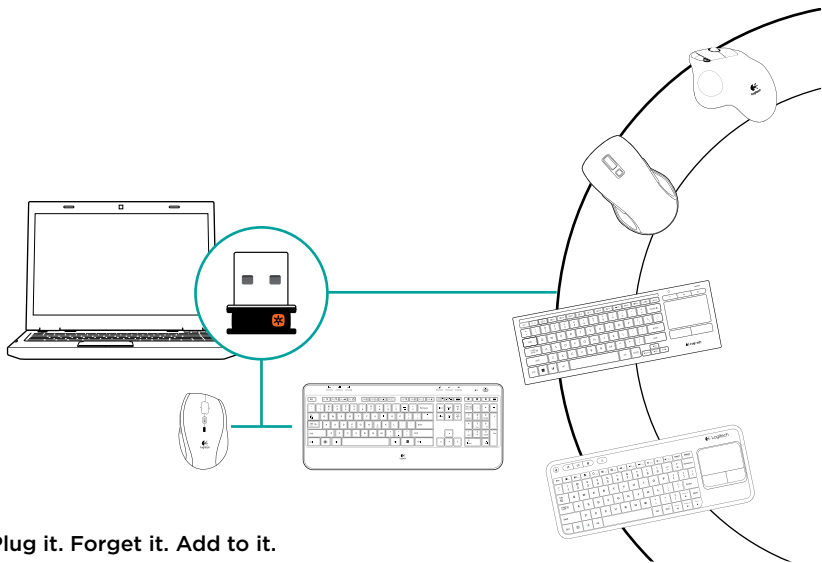

Plug it. Forget it. Add to it.

You've got a Logitech® Unifying receiver. Now add a compatible wireless keyboard or mouse that uses the same receiver. It's easy. Just start the Logitech® Unifying software* and follow the onscreen instructions. For more information and to download the software, visit www.logitech.com/unifying

Troubleshooting

Keyboard and mouse are not working

- ✔ **Check the USB connection.** Also, try changing USB ports.
- ✔ **Move closer?** Try moving the keyboard and mouse closer to the Unifying receiver.
- ✔ **Check battery installation.** Also check the battery power of each device.
(See *Battery management* for more information.)

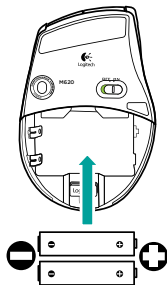
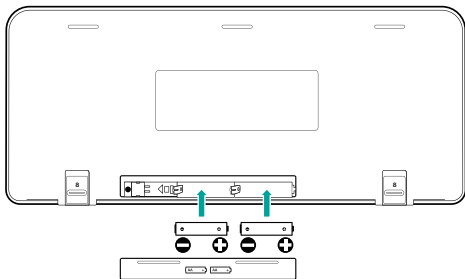

On the mouse bottom, slide the On/Off switch right to turn on the mouse. The Battery LED on the mouse top case should light green for 10 seconds. (See *Battery management* for more information.)

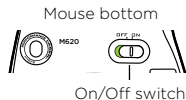

Troubleshooting

- ✓ **Are you experiencing slow or jerky cursor movement?** Try the mouse on a different surface (e.g., deep, dark surfaces may affect how the cursor moves on the computer screen).
- ✓ **Is the keyboard turned on?** Slide the keyboard Off/On switch to the **On** position, as shown in the image below. The keyboard Status icons should light up.

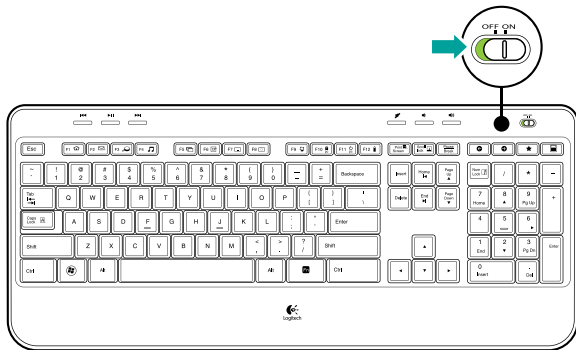

- ✓ **Re-establish the connection.** Use the Unifying software to reset the connection between the keyboard/mouse and Unifying receiver. Refer to the Unifying section in this guide for more information (p. 16).

Visit www.logitech.com/comfort for more information about using your product, and for ergonomics.

M/N:C-U0008
Rating: 5V $\overline{\text{---}}$ 100mA
FCC ID: JNZCU0008
IC: 4418A-CU0008
MADE IN CHINA





www.logitech.com/support/MK620

© 2014 Logitech. All rights reserved. Logitech, the Logitech logo, and other Logitech marks are owned by Logitech and may be registered. All other trademarks are the property of their respective owners. Logitech assumes no responsibility for any errors that may appear in this manual. Information contained herein is subject to change without notice.

621-000413.003